

PRODUCT SPECIFICATION

MODEL NO	HD09VR Highbay Series
INPUT	12VDC
DESCRIPTION	HIGHBAY MICROWAVE SENSOR SERIES (BLUETOOTH & REGULAR)

HIGHBAY MICROWAVE SENSOR SERIES (BLUETOOTH & REGULAR)



SHENZHEN HAISEN TECHNOLOGY CO.,LTD
13th Floor, C1 Building, Songshan Lake Intelligent Valley,
Liaobu Town, Dongguan City, 523808, Guangdong.
Contact us info@haisensz.com
www.haisensz.com

Series Work of Art
All Rights Reserved by HAISEN

WRITTEN BY	夏勇
CHECKED BY (R&D)	陈启东
CONFIRMED BY (SALES)	周蕾
DATE	2023.04.11

Features & Benefits



HD09VR Highbay Series

- 15M/49ft Patent Protected Module, Effectively anti-interference.
- Rotator & Remote control, app control for BLE version.
- 12VDC Input, 0-10V Dimming, with Daylight Harvesting and Photocell Function.
- ONE for ALL Installations Partnering With Different Receptacles & Brackets.

Demensions Unit:mm

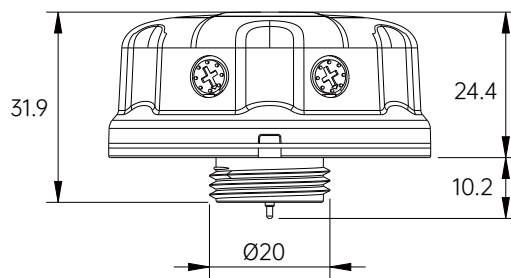
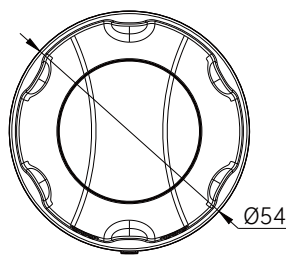

HD09VR-MH/HD09VR-MHB

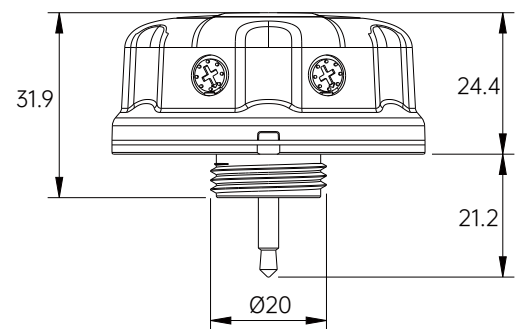

HD09VR-MH-1/HD09VR-MHB-1

Wiring Diagram

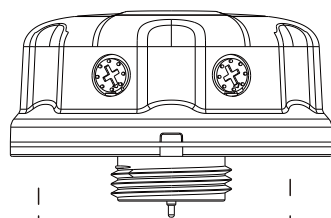

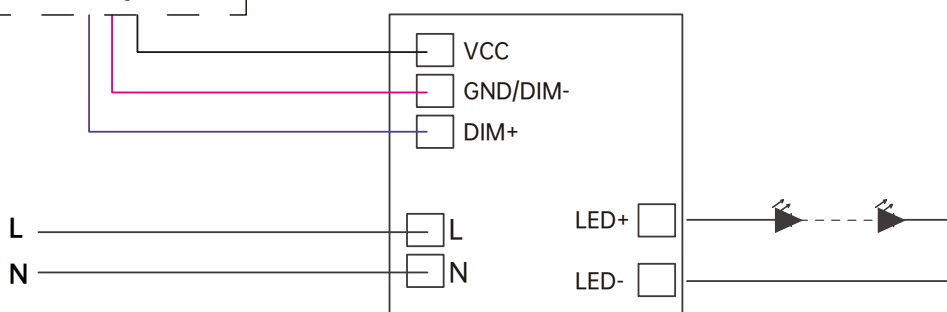

Black White +12V 12VDC input
 Pink GND 0/1-10V DIM
 Purple DIM+ 0/1-10V DIM+



Parameters

Model NO.		HD09VR
MICROWAVE INFORMATION	Frequency	5.8GHz±75MHz
	Microwave Power	<0.3mW
	Installation Height	15m/49.21 Max.
	Detection Distance	≥3m/9ft
	Detection Angle	30-150° (Without Glass Cover)
	Warranty	5 Years
SENSOR PARAMETER	Detection Area	Remote Control: 25%/50%/75%/100%
	Holdtime	Remote Control: 5s/30s/1min/3min/5min/10min/20min/30min Rotating switch: 5s/1min/5min/10min
	Daylight Threshold	Remote Control: 2Lux/10Lux/30Lux/50Lux/80Lux/120Lux / 200Lux/250Lux/300Lux/350Lux/400Lux/Disable
	Standby Dimming Level	Remote Control: 10%/20%/30%/50% Rotating switch: 0%/10%/30%/50%
	Standby Period	Remote Control: 0s/10s/30s/1min/5min/10min/30min/60min/+∞
	Dusk/Dawn Sensing/ Photocell	Daylight threshold as 30lux/50lux/80lux/120lux/200Lux/ 250Lux/ 300Lux/350Lux/400Lux Standby period as +∞ ; Standby dimming level as 10%/20%/30%
	Daylight Harvesting	1. Adjust "daylight" value higher than 50lux 2. Preset "standby period" 0S 3. press MW/PIR button 3 times till MW/PIR icons both blinking on LCD screen, daylight harvesting function enabled. (With BLE verison, press DH button, daylight harvesting function enabled.)
Warm-up Period	10s	
INPUT	Input Range	12VDC
	Voltage Range	10-15VDC
	Current	<30mA
OUTPUT	Signal	ON/OFF, DIM 0-10V
	Stand-by Power	<0.5W
ENVIRONMENT	Working Temp	-40°C~+70°C
	Storage Temp	-40°C~+80°C Humidity: 85% (non-condensation)
CERTIFICATE & STANDARDS	Environmental Requirements	In accordance with CE ROHS
	IP Rating	IP65

Model Information

Model Number	Sensor Type	Connector	Controller
HD09VR-MH	Microwave	3-Pin	Remote Control HD05R
HD09VR-MH-1		Audio Jack	
HD09VR-MHB 	Microwave	3-Pin	HAISEN BLUE APP
HD09VR-MHB-1 		Audio Jack	

Receptacle Options

Type A

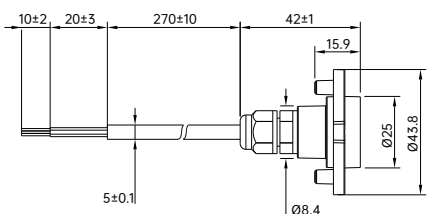
3 pogo-pin connection
 Wire color: Black/white, Pink, Purple
 The length of the wire: 330mm

HD07VRA-1

Audio Jack connection
 Wire color: Black/white, Pink, Purple
 The length of the wire: 330mm

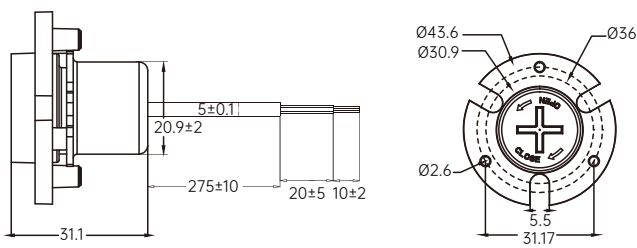
Type A-3

3 pogo-pin connection
 Wire color: Yellow, Pink, Purple
 The length of the wire: 330mm

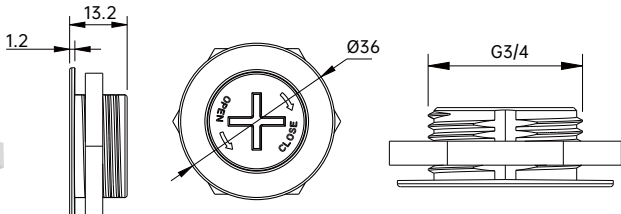
Type B

3 pogo-pin connection
 Wire color: Black/white, Pink, Purple
 The length of the wire: 330mm

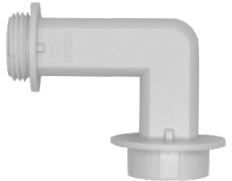
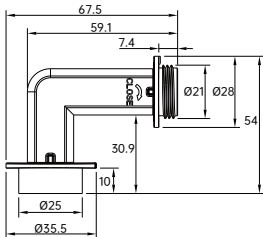
Type C

3 pogo-pin connection
 Wire color: Black/white, Pink, Purple
 The length of the wire: 300mm

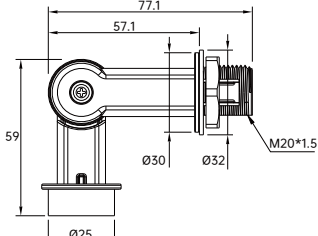
Detection Coverage

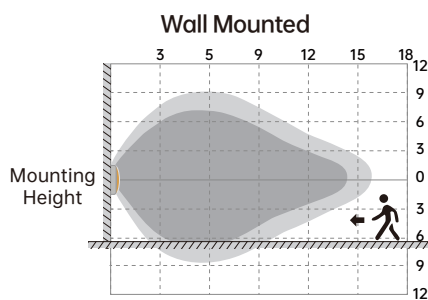
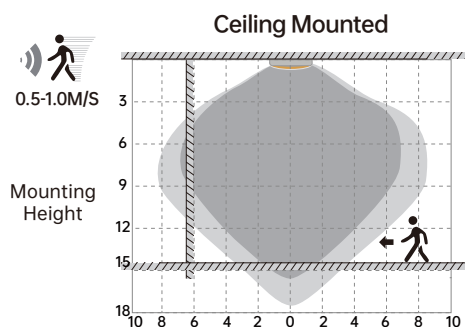

Highest mounting height is 15m

This figure indicates the maximum distance at the highest mounting height with 100% sensitivity.

Well Detected Area Possibly Detected Area

Performance

1. Daylight Harvesting

1. Adjust "daylight" value higher than 50lux
2. Preset "standby period" 0S
3. press MW/PIR button 3 times till MW/PIR icons both blinking on LCD screen, daylight harvesting function enabled. (With BLE version, press DH button, daylight harvesting function enabled.)

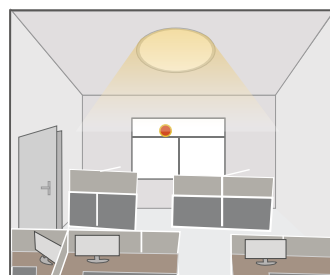
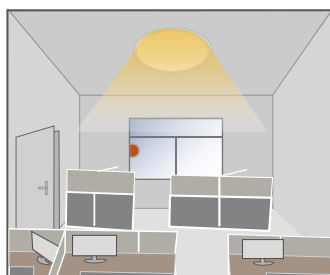
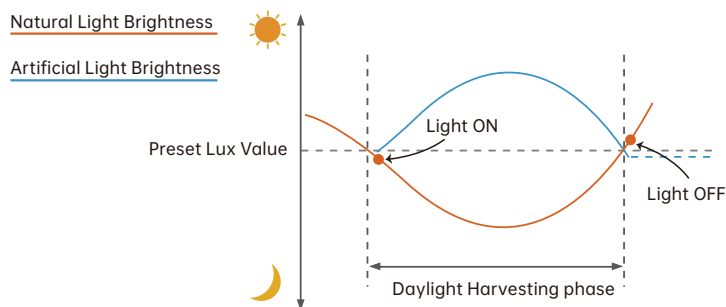

When ambient brightness is lower than preset lux level, sensor will turn on light automatically and keep dimming according to the change of the ambient brightness; when outside is getting darker, the inside will be brighter, and brighter darker.

Light OFF when ambient brightness becomes higher than the preset lux level.

2. Dusk/Dawn function

HD09VR is able to differentiate artificial light brightness from natural light after installed inside the fixture, and automatically turn off light when ambient brightness exceeds preset lux level.

Precondition of Dusk/Dawn function:

1. Standby period is +∞;
2. Standby dimming level is on 10%, 20% or 30%;
3. Daylight threshold is on 30lux/50lux/80lux/120lux/200Lux/250Lux/300Lux/350Lux/400Lux

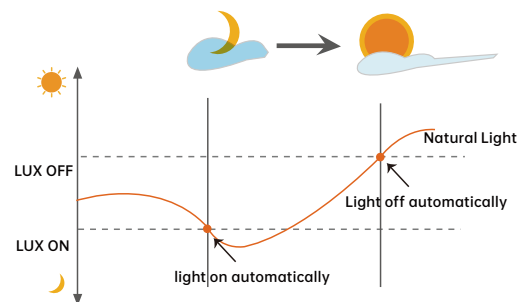

3. With Dusk/Dawn function

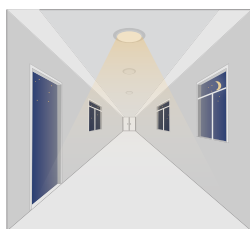

With insufficient ambient brightness, sensor turns on light and keeps it at standby dimming level even if there is no motion or presence.

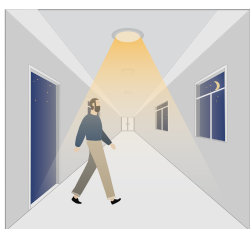

When sensor detects motion or presence it will bring the light level up to 100%.

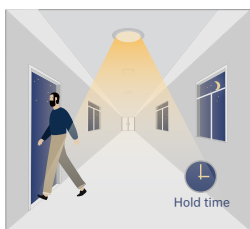

After motion is no longer detected, fixture remains at 100% for hold time.

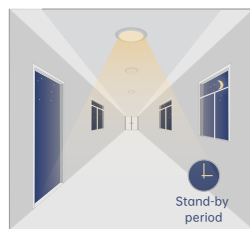

After pre-set hold time it will dim light to standby dimming level again and always keep it.

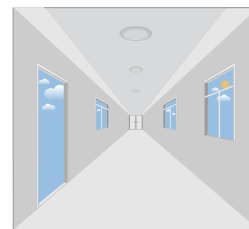

With sufficient ambient brightness, sensor will turn OFF light automatically.

4. Without daylight disabled

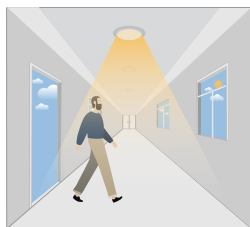

Sensor turns ON light when motion is detected.

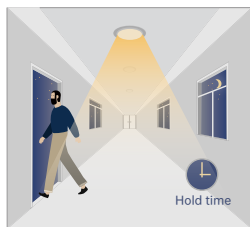

Sensor keeps for a hold time period after motion leaves

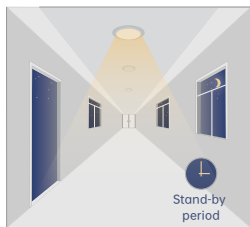

Sensor dims light to standby dimming level after hold time if there is still no motion

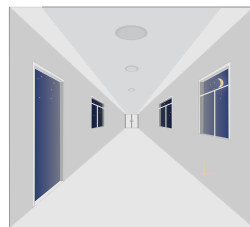

Sensor turns OFF light after standby period

5. With Daylight Threshold

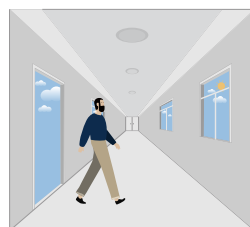

With sufficient daylight, the sensor keeps light OFF even motion gets detected

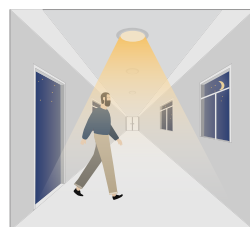

With insufficient daylight, the sensor turns light ON when motion gets detected

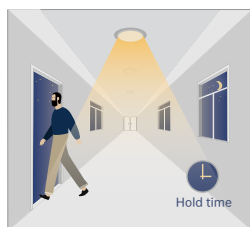

After there's no motion detected, the sensor keeps light ON 100% for holdtime.

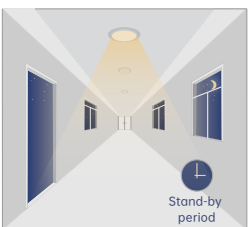

After holdtime, sensor dims light to standby dimming level for standby period. if the standby period has been set as 0s, sensor turns light OFF automatically after holdtime.

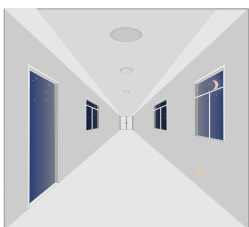

The sensor turns OFF light automatically after the standby period when there's no motion detected.



Attention

1. The sensor should be installed by qualified electrician and ensure power is OFF before installation.
2. Please read the instruction carefully before using the product and keep it well for other users to read any time.
3. We reserve the right to modify any incorrect text, image and technical parameters.
4. Any unauthorized modification is forbidden. Otherwise all guarantees will be immediately invalid.
5. Product could be optimized without prior notice.

Application Notes

1. Suitable for indoor application, half/completely outdoor environment conditions might be captured as moving signals to trigger the sensor.
2. Suitable for ceiling mount installation, adjust sensitivity properly if it's installed on side-wall because it gets more sensitive.
3. Adjust sensitivity properly when the sensor is applied in small/narrow/metal-built/with metal spaces.
4. Microwave sensor can't be placed under/inside metal shell; Microwave module must directly face the detection area with edge lower than light fixture.
5. Keep the sensor away from vibration equipments, air-conditioning outlets, smoke extractors alike conditions to avoid unwanted trigger.
6. Keep the sensor module away from AC input and DC output to avoid high/low frequency signal interference.
7. At least 2m/6.5ft distance between microwave sensors; 1.5m/4.9ft between the sensor and other wireless devices such as routers to avoid possible radio interference.
8. Daylight testing delivered in bright day without shadow or specially designed lampshade or lens.
9. Dimming performance differs when connected to different drivers; If the driver can't completely turn OFF, sensor can't either.
10. Input power voltage must be stable with float less than 10%.
11. The first time powered ON sensor, light will be ON 100% for about 10S then dims to standby level or OFF.
12. Distance detection is delivered by testing person about 165cm in open area as reference, the result differs by size and speed of moving objects, mounting height and real-life situation.